

Browning, John, Mewes, David (1978). **Australian Sugar Industry Locomotives**

**Extract: Locomotive Drawings only**



**THE AUSTRALIAN NARROW GAUGE RAILWAY MUSEUM SOCIETY**

IBSN 0 9596009 0 6

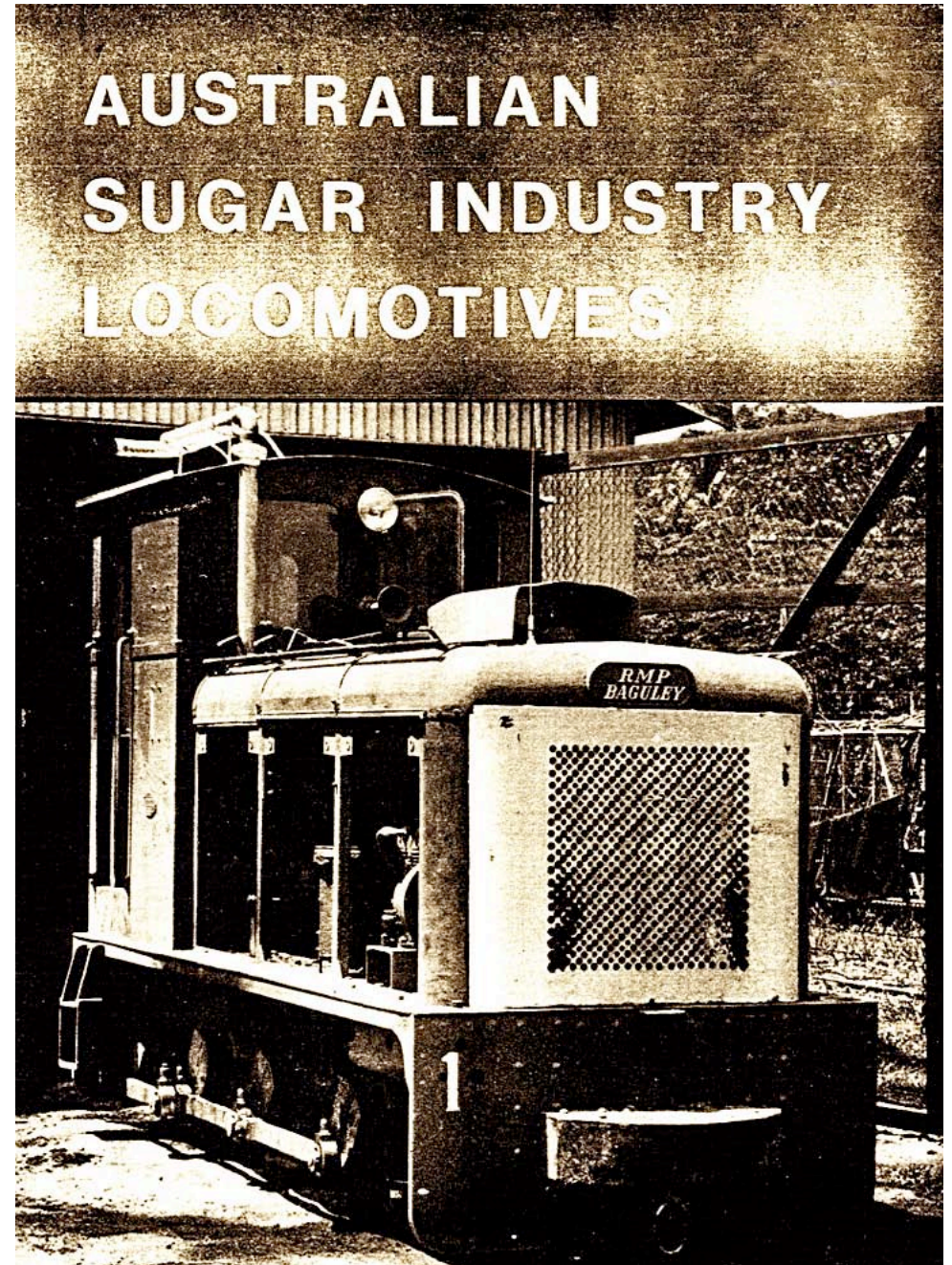

## **Introduction to the 2007 electronic edition**

Visitors to the canefields and viewers of historic canefield photographs understandably want to know what they are seeing, thus '*What locomotive is that?*' is one of the most common queries received by railfans and mill employees alike.

The answers for modern cane railways can often be found in loco lists on the LRRSA (Light Railway Research Society of Australia, [www.lrrsa.org.au](http://www.lrrsa.org.au)), CaneSIG ([www.zelmeroz.com/CaneSIG](http://www.zelmeroz.com/CaneSIG)), and other web sites. However, identifying historic locomotives has not been as easy since the 1978 listing by John Browning and David Mewes has been out of print for many years.

Hopefully this electronic reproduction, taken from the 1979 reprint, with amendment lists, will help serve the historic need. The pages were scanned as images and assembled into a pdf document. To assist in downloading, files have been assembled for individual mills as well as the full document.

The original publication was duplicated and bound as a half 8.5" x 11" format. The electronic pages have been slightly reduced as part of the scanning and reproduction process, but could be rescaled on your computer and printed in a larger size if required.

ANGRMS has changed locations since the publication of the original hard copy listing. Please use the address on the bottom of each page or visit the web site at [www.angrms.org.au](http://www.angrms.org.au).

Lynn Zelmer, July 2007

ANGRMS Webmaster

**AUSTRALIAN SUGAR INDUSTRY LOCOMOTIVES 1978**

**Current Rosters:  
Sugar Mills  
&  
Bulk Sugar Terminals**

**Compiled by John Browning & David Mewes**

**THE AUSTRALIAN NARROW GAUGE RAILWAY MUSEUM SOCIETY**

Published by the AUSTRALIAN NARROW GAUGE  
RAILWAY MUSEUM SOCIETY

P.O.Box 270, NORTH QUAY 4000, Queensland.

© AUSTRALIAN NARROW GAUGE RAILWAY  
MUSEUM SOCIETY 1978  
Reprinted 1979

National Library of Australia card number  
and ISBN 0 9596009 0 6

CONTENTS

Foreword	4
Introduction	5
Explanatory Notes	6
Locomotive & Equipment Builders	7
Sugar Mill Locomotive Lists (arranged from South to North)	9
Bulk Sugar Terminals	51
Notes on Locomotive Classification and Numbering	53
Map Index	54
Location Index	55
Drawings Index	56

Cover photo : Mulgrave Mill was the first to  
dieselise completely. Here number 1, Baguley/RMP  
0-6-ODM 3377 of 1953 stands by the shed.

Photo : E.W.H.Ward

FOREWORD

The locomotive lists in this booklet reflect the position as known to the compilers as of August 1976. The information contained is based on the observations and researches of the compilers and others, and we rely on our readers to keep the records up to date. The compilers would be very pleased to receive any reader's comments or any reports of observations. In this way, any errors or omissions may be corrected, and future developments recorded.

It is hoped that future booklets in this series may follow, providing more details of the mill tramway systems, their history and their locomotives and rolling stock.

Many people have helped the compilers in their researches for this publication, but special thanks are due to John Armstrong, George Bond, Keith McDonald, G.R.Prideaux, Eric Tonks, Rodney Weaver and Russell Wilson. However, all inaccuracies remain the responsibility of the compilers.

We are particularly grateful to Keith McDonald for allowing us to use some of his 3.5mm to the foot locomotive drawings, and to Ray Ellis for tracing them.

THE AUSTRALIAN NARROW GAUGE  
RAILWAY MUSEUM SOCIETY

This booklet has been published by the Australian Narrow Gauge Railway Museum Society. The Society's main purpose is the establishment of a museum of locomotives and other equipment used on the sugar mill tramways and other light railways. The museum, to be located near Brisbane, will be centred around an operating railway, and a sizeable collection of steam and internal-combustion locomotives has already been acquired. Members receive a bi-monthly magazine "Stack Talk", which includes news and articles on the mill tramway systems, and also a monthly "Newsletter" about Society activities and achievements.

If you are interested in joining the Society, or require further details, please write to:

The Membership Secretary,  
A.N.G.R.M.S.,  
P.O. Box 270,  
NORTH QUAY 4000  
Queensland.

INTRODUCTION

This publication has been produced as a guide for those interested in the locomotives used in the Queensland Sugar Industry. It is hoped that it will go some way to make more people aware of the extent and importance of the Cane Tramways of Queensland.

To give readers some idea of the scale of operations, trains of up to 1,000 tonnes are now hauled on the Victoria Mill system, which must handle 18,500 tonnes each day. 20 main line diesel locos haul 4,700 cane bins on the tramway system, the longest line of which stretches 35 miles from the mill. Train schedules are so complex that they are worked out by computer. The value of a locomotive and loaded train can be as much as \$750,000! It is quite likely that the next generation of cane haulage will be 36-tonne C-C diesel hydraulic locos hauling 14-tonne bogie cane bins. Although Victoria Mill is the largest, the other mills have smaller-scale versions of the same thing - sophisticated equipment and intensive working. Nevertheless, the traditional charm of the narrow gauge can still be seen, for steam locomotives remain in daily use at two mills, and ancient diesel locos haul quaint navvies' trains at quite a number.

The cane tramways normally work during the "crush" for six months of the year, from June to November. During the "slack", the locomotives and tramway systems receive heavy maintenance.

Sugar Mills are large industrial plants, and the tramways usually run on private property. It is important to remember that access is only available through the good will of the owners concerned. Permission should be obtained before entering workshops and sheds. Be sure not to be a nuisance or hold up production, and be aware of the need for safety at all times.

THE MAPS

The maps in this booklet are provided to give the reader an indication of the location of each sugar mill and its main tramlines. Reference to the appropriate map will be found at the head of each locomotive list. It is suggested that these maps be used in conjunction with a inexpensive road map, such as the Shell map of Queensland. For a more accurate guide to the roads and tramways in each mill area, there is no substitute for the Australian Government 1 : 100 000 Topographic Maps, although even these contain some inaccuracies, and are expensive.

Browning, John, Mewes, David (1978). **Australian Sugar Industry Locomotives**

EXPLANATORY NOTES

Arrangement of locations

The sugar mills are arranged geographically, starting with the most southerly and moving northwards. Bulk sugar terminals appear at the end of the booklet.

Track Mileage and Gauge

This information appears at the head of each list.

Loco livery

As an aid to recognition, the basic colour scheme applied to the main-line locomotives at each location is shown. Navy locos and line cars may be painted differently. Where there is no consistent livery applied to locos, the colour of each one is shown in the "Remarks" column.

Number and/or Name

This information appears in the first column of each list. Official numbers or names not carried are shown in brackets.

Wheel arrangement

The Whyte system of classification is used in the main, but the Continental system is used in the case of bogie diesel locos. However, when the driving wheels of internal-combustion locos are not connected by outside rods, but by chains, this is denoted by 4w (four wheeled) or 6w (six wheeled). If only the rear axle is powered, this is shown as 2-2w.

- DM - Diesel locomotive with mechanical transmission
- DH - Diesel locomotive with hydraulic transmission
- PM - Petrol locomotive with mechanical transmission
- PH - Petrol locomotive with hydraulic transmission
- R - Railcar - a vehicle designed primarily as a personnel carrier
- T - Side tank

Maker

The builder is shown in the next column. A list of abbreviations used appears on page 7 opposite.

reb. - Rebuilt. This is only included where the loco carries a plate denoting its rebuild, or where radical structural change has resulted.

Maker's number, year of construction, and model/type

This information appears in the next three columns.

Remarks

The last column contains remarks (usually by reference to notes below)

- Dsm. - Dismantled
- Dlct. - Derelict
- OOU. - Permanently out of use
- Pvd. - Preserved on site

Brake wagons

These units are heavy unpowered vehicles, constructed with loco-type frame ballasted for extra weight. They carry an air compressor powered by a diesel or petrol engine, and are air braked. The brake wagon is usually marshalled at the rear of a train, and it is controlled from the loco by means of radio signals, to supplement the loco's braking power.

LOCOMOTIVE AND EQUIPMENT BUILDERS

AE	Avonside Engine Co. Ltd., Bristol, UK.
BF	Bundsberg Foundry Co., Bundsberg, Qld.
Bg/DC	E.E.Baguley Ltd., Burton-on-Trent, UK, for Drewry Car Co. Ltd., London, UK.
Bg/RMP	E.E.Baguley Ltd., Burton-on-Trent, UK, for Railway, Mine and Plantation Equipment Ltd., UK.
Clyde	Clyde Engineering Pty. Ltd., Granville, NSW.
ClydeQ	Clyde Engineering (Qld.) Pty. Ltd., Eagle Farm, Qld., for Clyde.
ComEng	Commonwealth Engineering (Qld.) Pty. Ltd., Salisbury North, Qld.
EMB	E.M.Baldwin & Sons Pty. Ltd., Castle Hill, NSW.
FH	F.C.Hibberd & Co. Ltd., Park Royal, UK. ("PLANET")
Gemco	George Moss Pty. Ltd., Leederville, WA.
Hansen	Hansen's Motor & Engineering Works, Ingham, Qld.
HC	Hudswell, Clarke & Co. Ltd., Leeds, UK.
HE	Hunslet Engine Co. Ltd., Leeds, UK.
JF	John Fowler & Co. (Leeds) Ltd., Leeds, UK.
MM	Malcolm Moore Ltd., Port Melbourne, Vic.
MR	Motor Rail Ltd., Bedford, UK. ("SIMPLEX")
NQE	North Queensland Engineering
Pacific	Pacific Construction Equipment Co., Hornsby, NSW.
PE	Perry Engineering Co. Ltd., Gawler, SA.
Plasser	Plasser (Australia) Pty. Ltd., Girraween, NSW.
RH	Ruston & Hornsby Ltd., Lincoln, UK.
SS	Sharp, Stewart & Co. Ltd., Glasgow, UK.
Tamper	Tamper (Australia) Pty. Ltd., Airport West, Vic.
Walkers	Walkers Ltd., Maryborough, Qld.
Wilson	Wilson Engine Co.
Wkm	D.Wickham & Co. Ltd., Ware, UK.

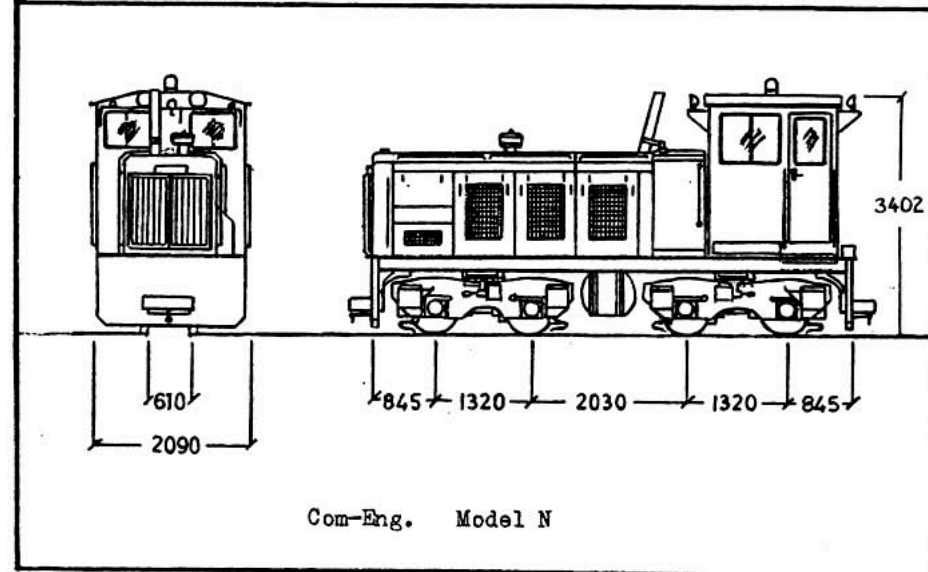
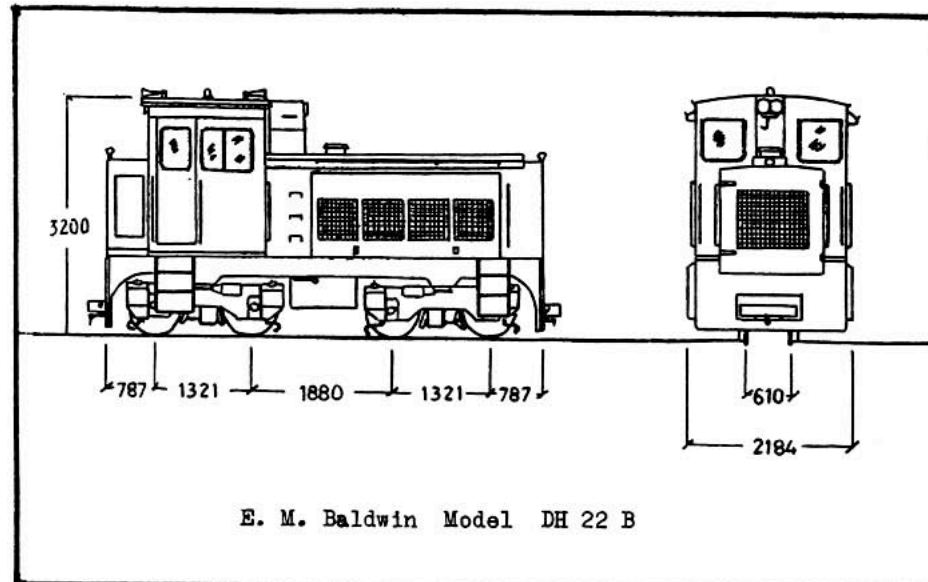
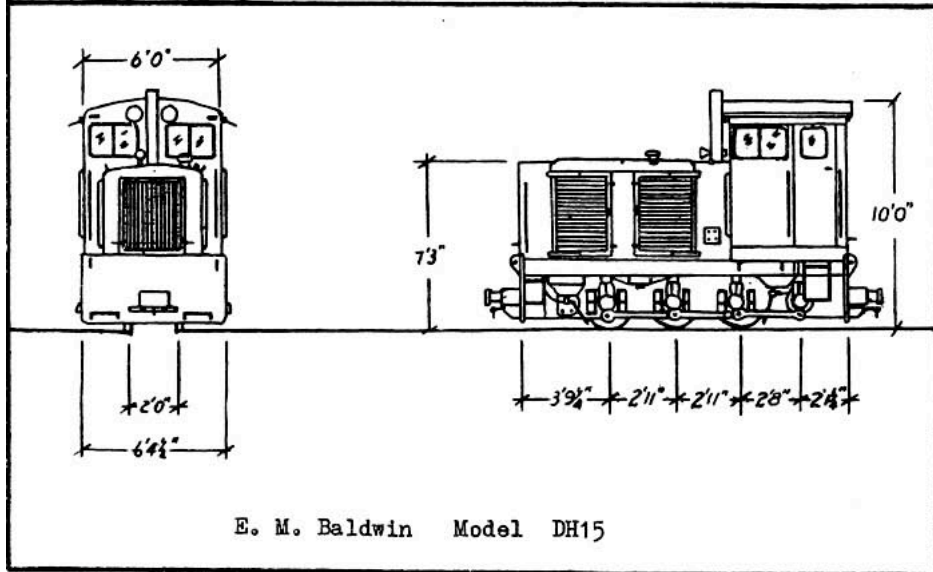
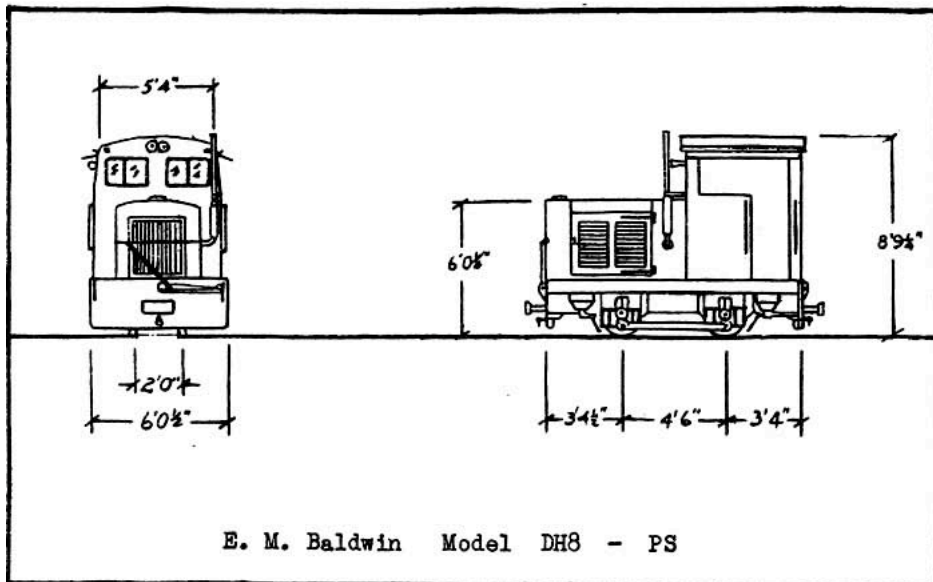

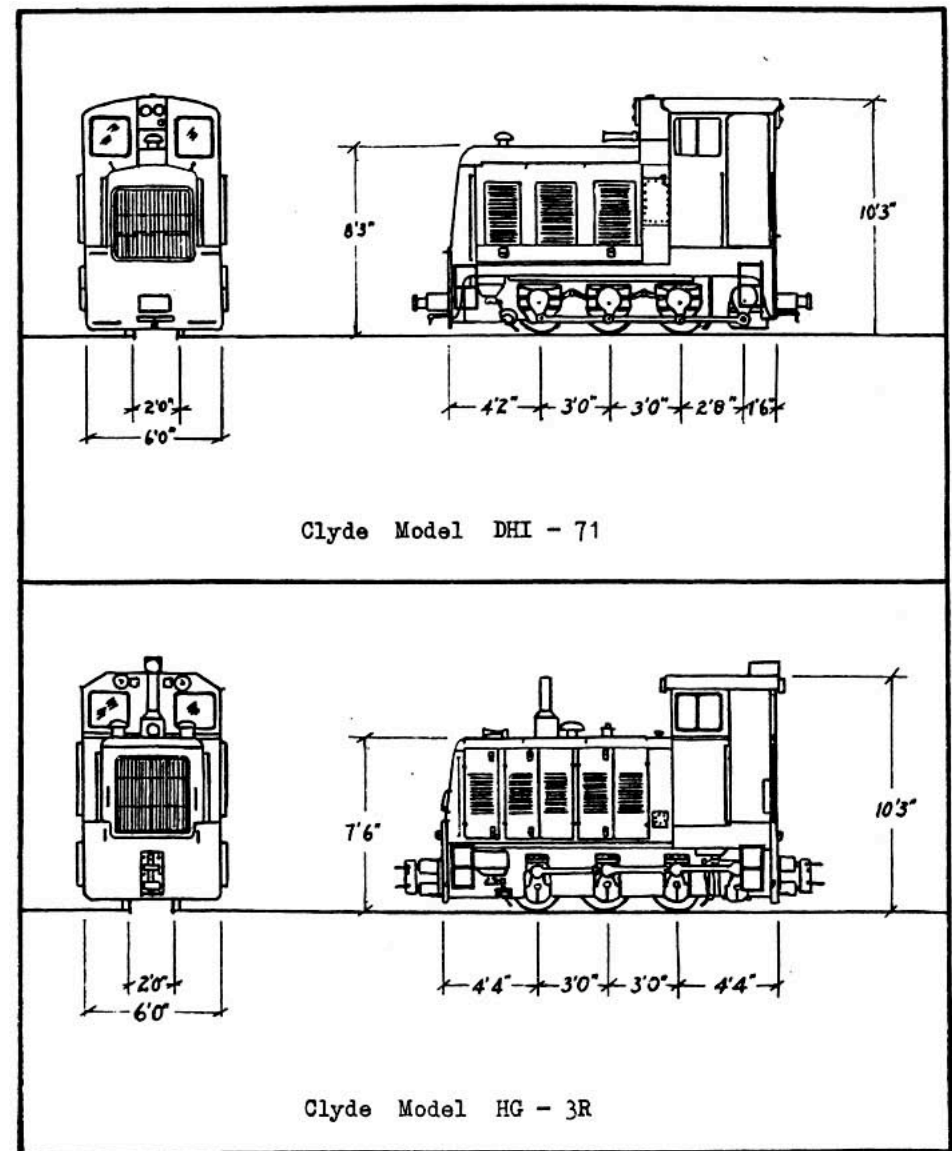
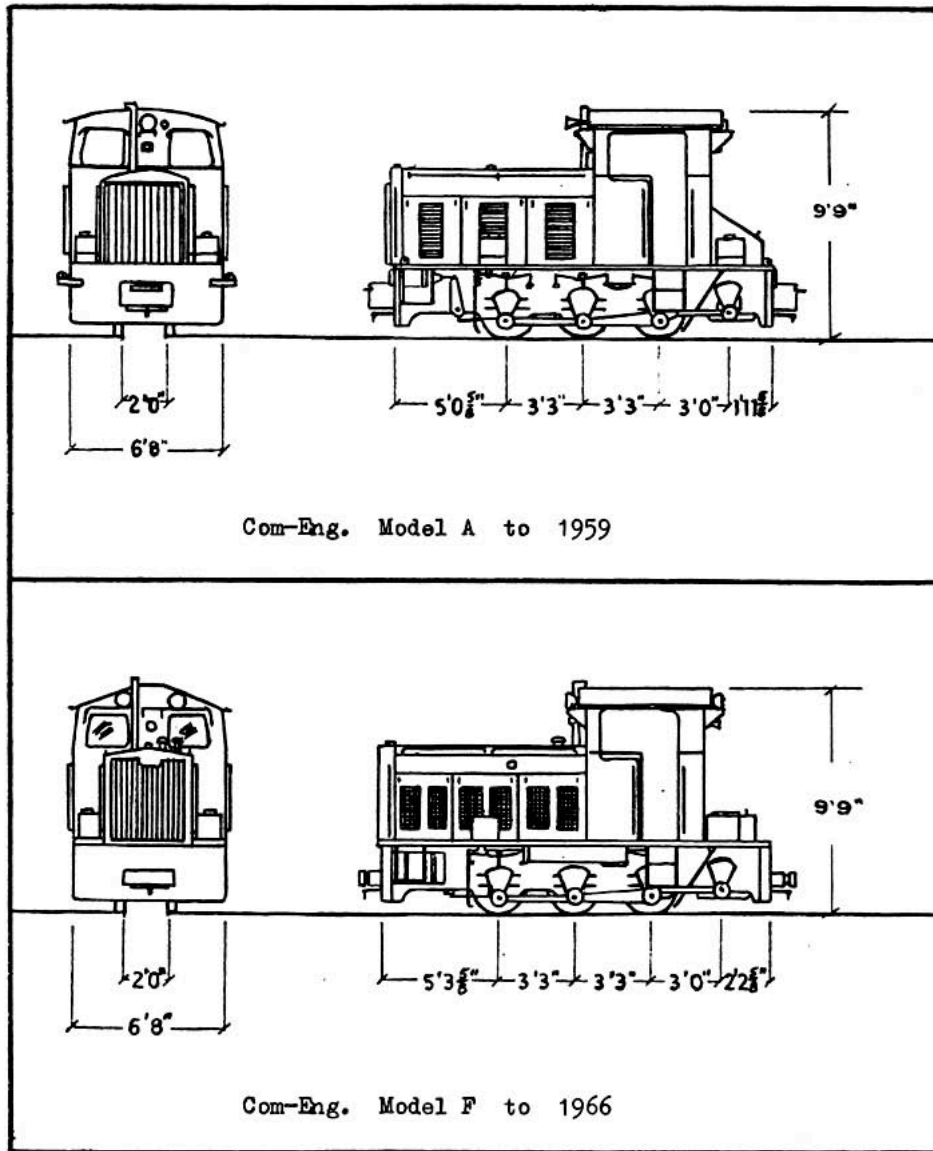

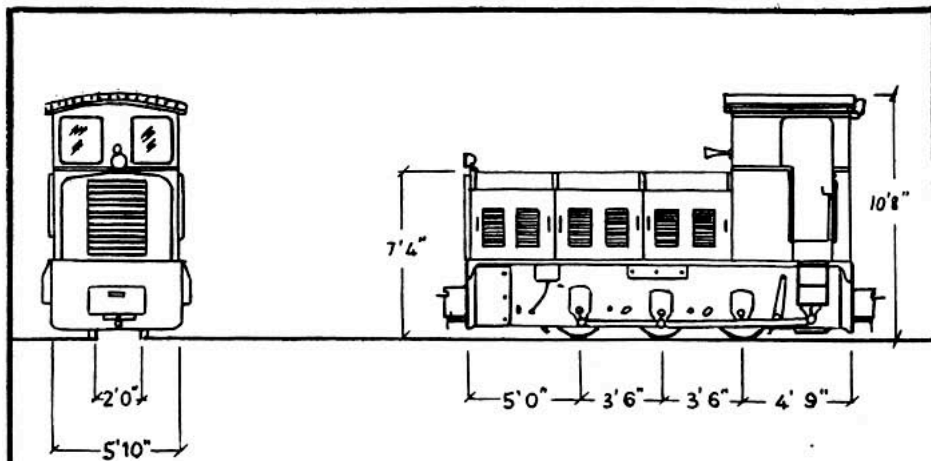

Baguley / Drewry 150hp loco.

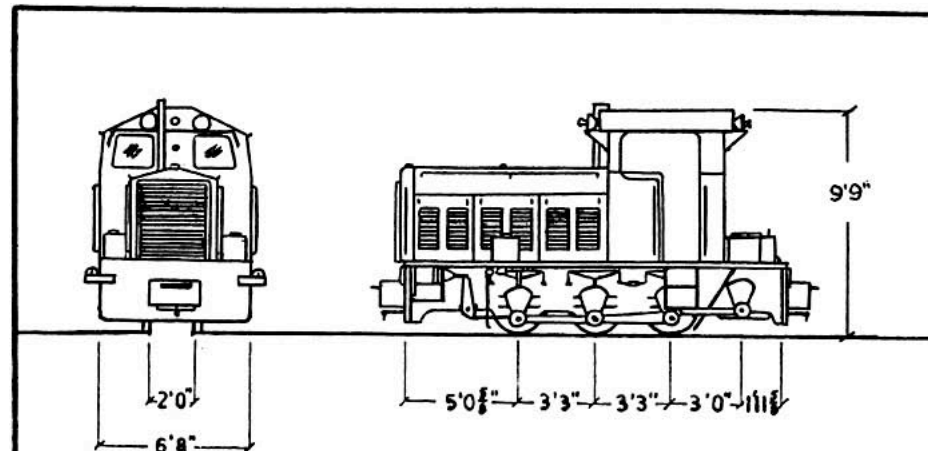

Com-Eng. Model A 1960 to 1966

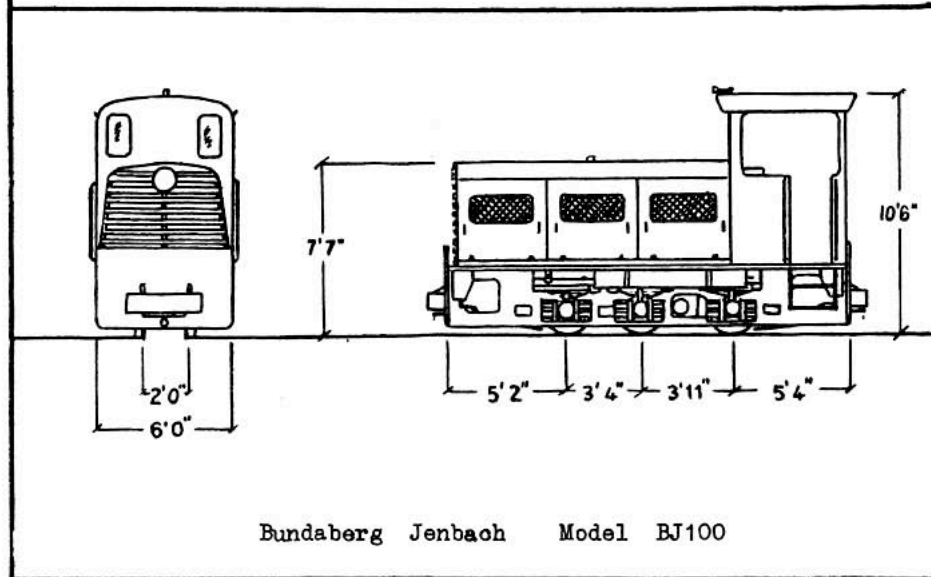

Bundaberg Jenbaoh Model BJ100

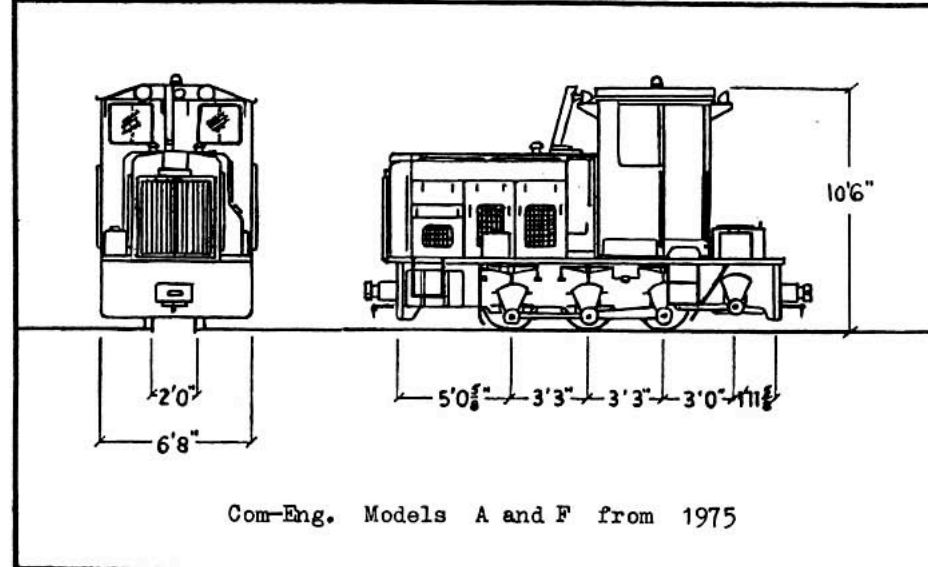

Com-Eng. Models A and F from 1975



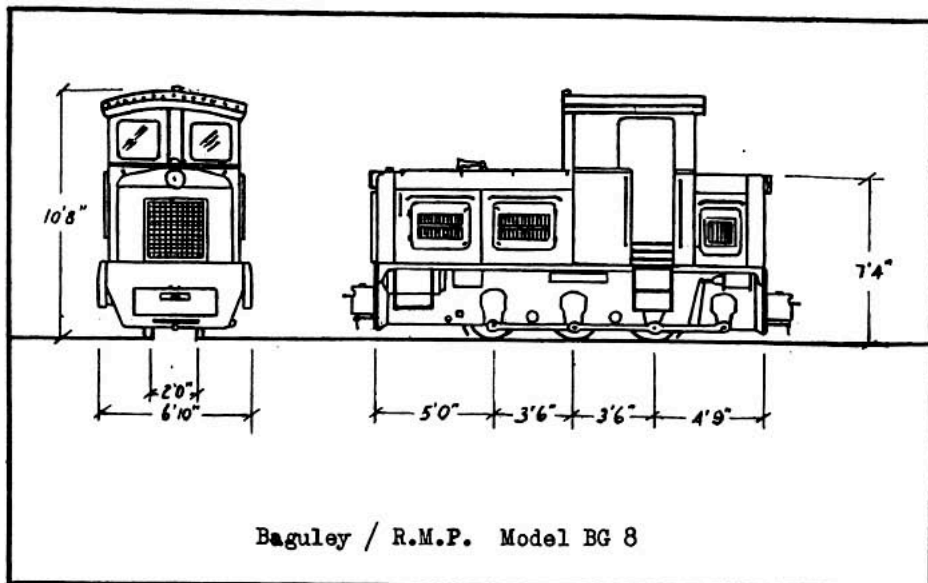

Baguley / R.M.P. Model BG 8

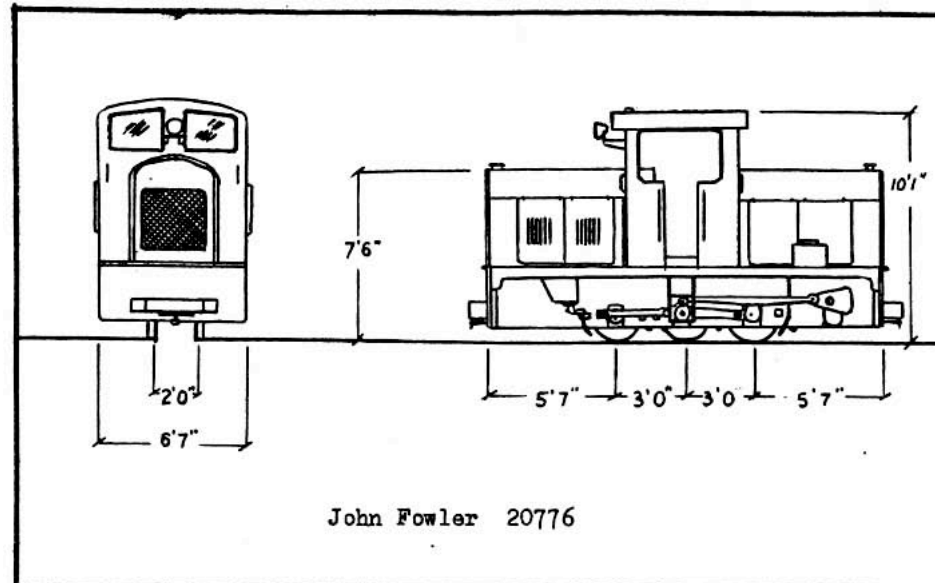

John Fowler 20776

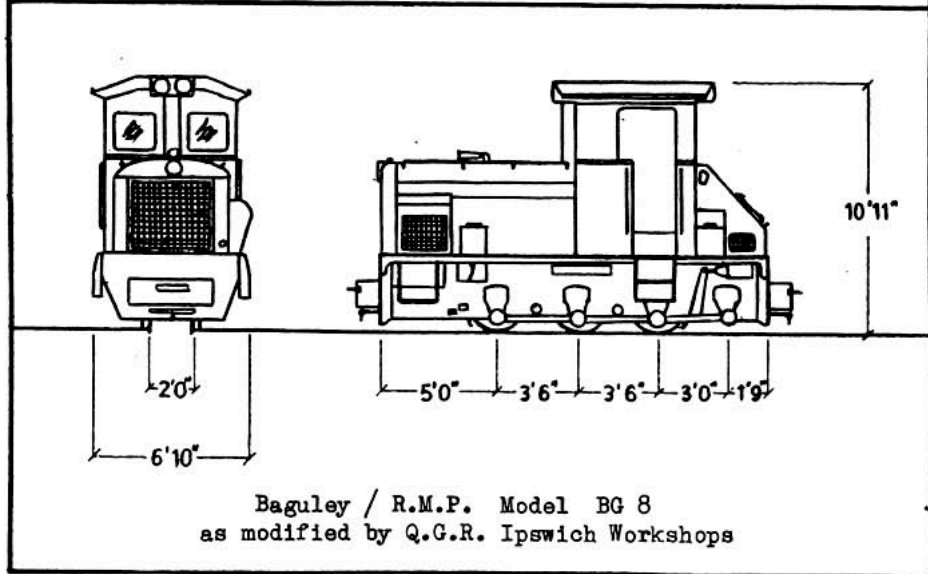

Baguley / R.M.P. Model BG 8  
as modified by Q.G.R. Ipswich Workshops

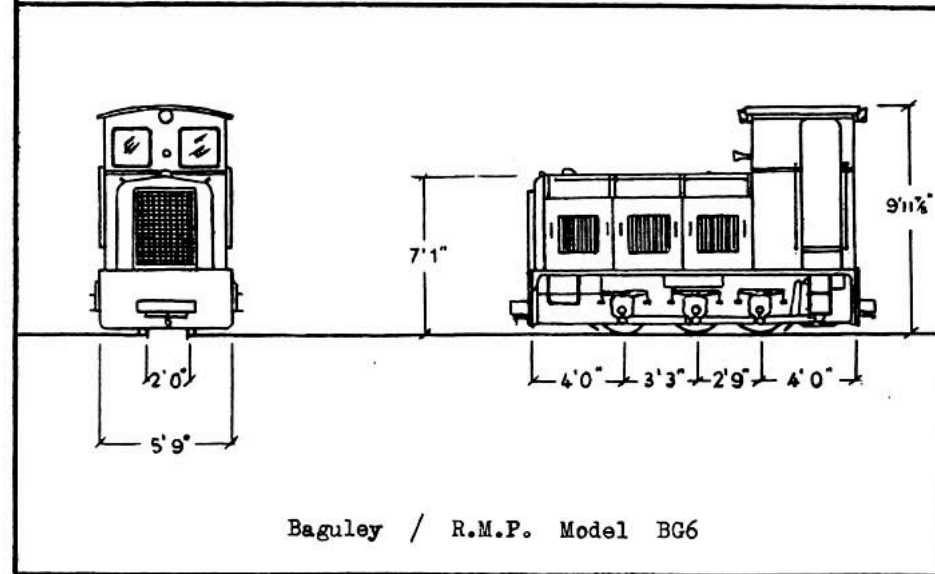

Baguley / R.M.P. Model BG6

NOTES ON LOCOMOTIVE CLASSIFICATION AND NUMBERING

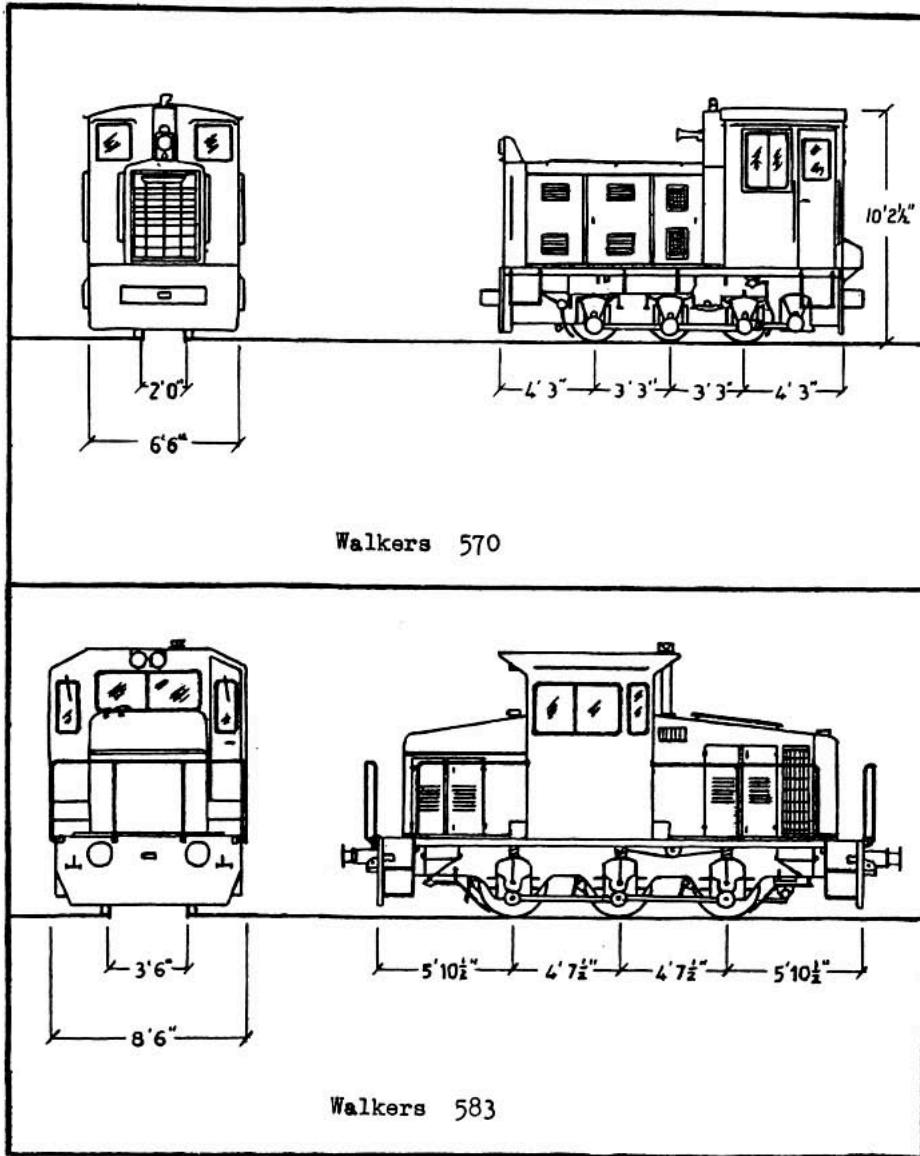

Walkers 570

Walkers 583

Bundaberg Foundry

Classification of diesels is by the letters BJ (Bundaberg Jenbach - built under licence from Jenbacher Werke, Austria), followed by a number indicating nominal horsepower. Steam locos were built under licence from John Fowler & Co. (Leeds) Ltd., Leeds, UK.

Baguley/Drewry

Locomotives supplied to Queensland were either 135 hp or 150 hp nominal. The dates recorded in this booklet are the official dates ex works, which may vary from those shown on worksplates. Baguley kept builder's numbers in the 2xxx series specially for Drewry orders.

Baguley/RMP

Type BG6 was fitted with Gardner 6LW engine, BG8 with 8LW.

Clyde & Clyde (clt.)

Model DHI-71 is 170 hp 18 ton design, and HG-3R is 263 hp 18-24 ton design. The initial series of DHI locos were numbered from 1 to 7, but from 1955, the locos were numbered with a prefix denoting year of manufacture, followed by a serial number. Engines are by GM.

Com-Eng.

Until 1959 (serial number 35), classification was by an initial letter. However, this scheme was discontinued and replaced by another which indicates general type (first letter) and engine or transmission variations (second letter). Such letters were also allocated retrospectively to those locos already built under the old classification scheme. Code letters of the general types are as follows:

A - 0-6-0 DM or DH.	14-18 ton. 150-205 hp.
C - 0-4-0 DH.	9-12 ton. 112 hp.
F - 0-6-0 DH.	19-25 ton. 250-277 hp.
G - 4w DM	4-8 ton. 76 hp.
N - B-B DH	

The first two numbers denote the code for the particular variant (numbered in sequence from 10 upwards). The last two or three numbers are serial number.

E.M.Baldwin

Classified by DM or DH (Diesel mechanical or hydraulic), and a figure giving the weight in tonnes. The suffix B or T denotes Bogie and Tunnelling loco respectively. The numbering system is not completely consistent, but contains a code number (early locos only), an order number, a number indicating the unit's part in the order, and numbers indicating month and year of despatch. Engines are mostly by GM and Caterpillar.

Motor Rail

An earlier numbering scheme (up to 9999) was replaced by one where locos in the 10xxx range were 60 hp nominal and those in the 20xxx range were 40 hp nominal.

Perry

Numbers consist of job number, year of construction, and serial number of locomotives built under that job number.

Ruston & Hornsby

Classification is by nominal horse power plus DL (Diesel locomotive). The suffixes G and U indicate flameproofed and underground locos respectively. The number is in a series of all Ruston equipment, which includes the engine carried by the loco.

DRAWINGS INDEX

Baguley/Drewry 150 h.p.	22
Baguley/RMP BG6	46
Baguley/RMP BG8	40
Baguley/RMP BG8 as modified by Q.G.R. Ipswich Workshops	40
E.M.Baldwin DH8-PS	8
E.M.Baldwin DH15	8
E.M.Baldwin DH22B	14
Bundaberg Jenbach BJ100	22
Clyde DHI-71	20
Clyde HG-3R	20
Com-Eng A to 1959	16
Com-Eng A 1960-1966	38
Com-Eng A & F from 1975	38
Com-Eng F to 1966	16
Com-Eng N	14
John Fowler 20776	46
Walkers 570	50
Walkers 583	50

THE AUSTRALIAN NARROW GAUGE RAILWAY MUSEUM SOCIETYAUSTRALIAN SUGAR INDUSTRY LOCOMOTIVES 1978Amendment list 1. October 1978

- p.7 Locomotive and Equipment Builders**  
Add CEA ComEng Aresco Pty. Ltd., Dry Creek, SA.  
Amend NQE to North Queensland Engineers & Agents Pty. Ltd., Cairns, Qld  
Add (Canron Rail Group) to Tamper details.
- p.11 ISIS CENTRAL SUGAR MILL CO. LTD.**  
Amend loco livery details to Yellow & Grey
- p.18 PLANE CREEK CENTRAL MILL CO. LTD.**  
Amend B12 to D12 (Form. B12)
- p.19 RACECOURSE CO-OPERATIVE SUGAR ASSOCIATION LTD.**  
Add OLD SMOKEY to RH 392120  
Amend EMB locos to  
LEO 2-2WDH EMB 6-2612-1-10-68 1968 DHC 8M/ML (c)  
2-2WDH EMB 6-2612-2-11-68 1968 DHC 8M/ML (c)  
Add 2-2PWR Hansen 1718  
Add Ballast regulator  
4WDH Tamper 1775577 1978 BESM1
- p.23 NORTH ETON CO-OPERATIVE SUGAR MILLING ASSOCIATION**  
Amend model number of BF 13 to BJ220
- p.25 FARLEIGH CO-OPERATIVE SUGAR MILLING ASSOCIATION LTD.**  
Add Brake wagon  
6W EMB 7901-1-6-78 1978 BV24
- p.26 PROSERPINE CO-OPERATIVE SUGAR MILLING ASSOCIATION**  
Add (c) to Gemco  
Add footnote (c) Returned to builders for modification, 1978  
Add Ballast regulator  
4WDH CEA BR683 1978
- p.27 PIONEER SUGAR MILLS LTD., INKERMAN MILL**  
Amend loco livery details to Yellow (LT'L TOOT is Blue,  
IYAH is Orange-Red)  
Delete notes of individual loco colours.
- p.30 THE AUSTRALIAN ESTATES CO. LTD., KALAMIA MILL**  
Add (c) to AIRDMILLAN and DELTA  
Add footnote (c) Fitted with EMB soundproofed cab, 1978
- p.32 PIONEER SUGAR MILLS LTD., PIONEER MILL**  
Amend MACDESME to McDESME  
HAUGHTON SUGAR COMPANY, INVICTA MILL.  
Amend loco livery details to Cream (NORTHCOTE & SELKIRK are Yellow)
- p.34 CSR LTD., VICTORIA MILL**  
Amend MOORE to O-4-ODH  
Delete S2 (scrapped?)
- p.39 SOUTH JOHNSTONE CO-OPERATIVE SUGAR MILLING ASSOCIATION LTD.**  
Delete Q.G.R. names and numbers from ComEng A157111, ComEng AA1544  
and Bg/RMP 3390  
Add OOU to 12 & 17.
- p.41 HOWARD SMITH INDUSTRIES PTY. LTD., MOURILYAN MILL**  
Delete number and name from ComEng B1112 and add 8  
Add TOWNSVILLE O-6-0 HC 1099 1919 OOU(f)  
Add to footnote (d) On loan to Goondi Mill, 1978  
Add footnote (f) Stored for Australian Sugar Industry Museum,  
Mourilyan. Ex Victoria Mill, 1977. Formerly ex  
Goondi Mill, 1956.

Browning, John, Mewes, David (1978). Australian Sugar Industry Locomotives

THE AUSTRALIAN NARROW GAUGE RAILWAY MUSEUM SOCIETY

AUSTRALIAN SUGAR INDUSTRY LOCOMOTIVES 1978

Amendment list 2. February 1979

- p.7 LOCOMOTIVE AND EQUIPMENT BUILDERS  
Amend PE Perry Engineering Co. Ltd., Gawler, SA. to  
PE Perry Engineering Co. Ltd., Mile End, SA.
- p.11 ISIS CENTRAL SUGAR MILL CO. LTD.  
Delete SS 4619 (sold for preservation)
- p.12 THE MILLAQUIN SUGAR CO. PTY. LTD., MILLAQUIN MILL  
Delete 6 and 8 (transferred to Qunaba Mill)  
Delete footnotes (a) and (b).  
Delete special note regarding steam locomotive repairs.
- p.13 THE MILLAQUIN SUGAR CO. PTY. LTD., QUNABA MILL  
Add OOU to DELTA and SKIPPER.  
Add 5 0-6-2T BF 6 1952 (f)  
Add 6 0-4-2T BF 3 1952 (g)  
Add footnote (f) ex Millaquin Mill, 6, 1978.  
Add footnote (g) ex Millaquin Mill, 8, 1978.  
Formerly ex Mourilyan Mill, 8, 1966.
- p.18 PLANE CREEK CENTRAL MILL CO. LTD.  
Amend date of ComEng FA1037 to 1960  
Amend date of RH 371381 to 1954.
- p.25 FARLEIGH CO-OPERATIVE SUGAR MILLING ASSOCIATION LTD.  
Amend date of ComEng AI3271 to 1963.  
Amend EMB 5-774-6-63 1963 to 5-774-6-64 1964.  
Add date 1939 and (c) to MR 7369.  
Add footnote (c) ex ?  
Formerly ex James N.Connell Ltd., Coatbridge,  
Midlothian, Scotland; ex Glasgow Corporation  
Housing Department, Scotland, 1949.
- p.34 CSR LTD., VICTORIA MILL.  
Add number S1 to MR 10181.  
Add number S3 to MR 10381.  
Reinstate S2 (remains still in scrap disposal area)  
Add builder's number 2821 to unidentified MR.  
Add V5 2-2WPMR Hansen 1978
- p.35 Amend model number of EMB 4962-4-73 to BV16.
- p.36 CSR LTD., MACKNADE MILL.  
Delete note regarding bogie locos from loco livery details.  
Add number (1) to MR 10232.  
Amend 2-2WPMR Clyde to 2-2WPMR ClydeQ.
- p.37 TULLY CO-OPERATIVE SUGAR MILLING ASSOCIATION.  
Amend date of JF 21912 to 1936.
- p.39 SOUTH JOHNSTONE CO-OPERATIVE SUGAR MILLING ASSOCIATION.  
Amend ComEng AD1553 to AD1453.
- p.43 CSR LTD., GOONDI MILL  
Amend date of JF 18260 to 1929.
- p.43 CSR LTD., GOONDI MILL  
Add (g) to Clyde 56-93  
Amend 0-4-ODH EMB to  
6 4wDH EMB 8002-1-8-78 1978 DH12 0.4.0  
Amend No.4 SIMPLEX to  
8 (No.2 SIMPLEX) 4wDM MR (b)  
Delete JF 18808 (scrapped, 1978)  
Add DL15 NERADA 0-6-ODM ComEng B1111 1956 AA (1)  
Add footnote (g) Fitted with EMB soundproofed cab, 1978  
Add footnote (h) ex Hambleton Mill, c.1965. Converted from 4wPM  
Add footnote (i) On loan from Mourilyan Mill, 1978. Formerly ex  
Q.G.R. Innisfail Tramway, DL15 NERADA, 1977.
- p.44 BABINDA CO-OPERATIVE CENTRAL MILL SOCIETY LTD.  
Amend date of ComEng A1821 to 1957  
Amend date of ComEng A2027 to 1958
- p.47 MULGRAVE CENTRAL MILL CO. LTD.  
Amend ComEng A1010 to ComEng B1010  
Add (No.1 SIMPLEX) and (a) to MR 4207  
Amend 4wDM 1924 to  
(No.2 SIMPLEX "THE PIE CART") 4wDM Mulgrave 1960  
Add footnote (a) Converted from 4wPM  
Add date 1972 to NQE brake wagon
- p.48 CSR LTD., HAMBLEDON MILL  
Amend (4) to 4  
Amend 4 to (4) and add builder's number 2090  
Amend 7 to (7)
- p.49 MOSSMAN CENTRAL MILL CO. LTD.  
Amend loco livery details to Pale Blue & Pale Yellow (MOSSMAN  
is Bright Yellow & Pale Blue)  
New loco livery for 1979 will be  
Bright Yellow & Pale Blue.  
Amend FAUGH-A-BALLOUGH to FAUGH A BALOUGH